

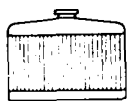

1



XU10

XM
230-00/1

1

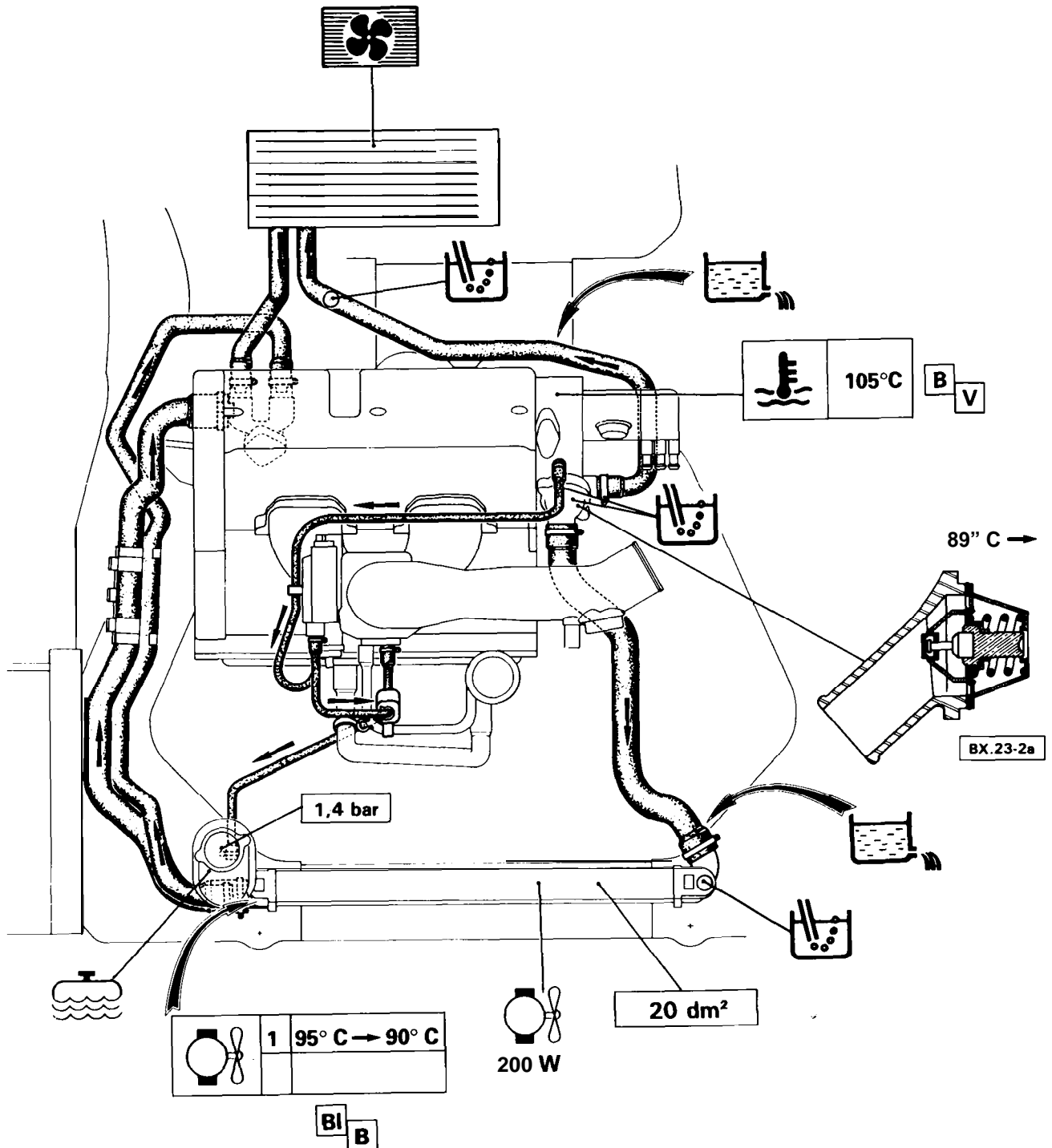
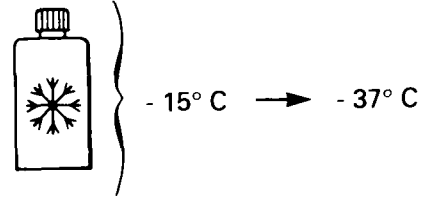
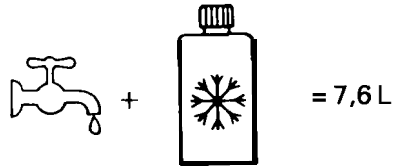

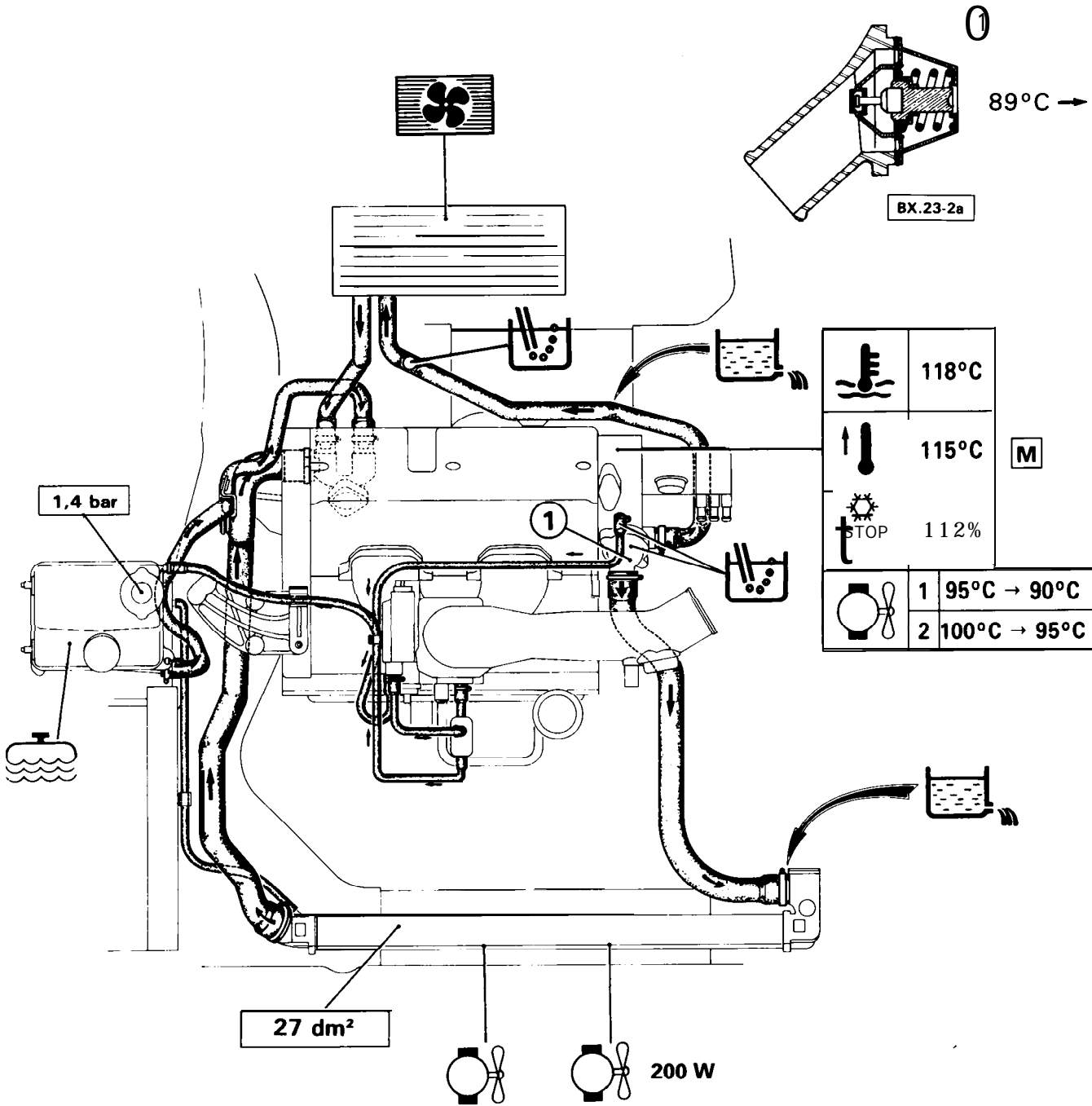
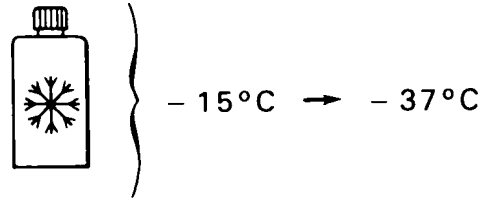
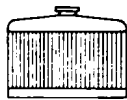

	118°C	
	115°C	M
	112%	
	1	95°C → 90°C
	2	100°C → 95°C



1

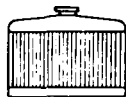

XU10

X M
230-00/1

3

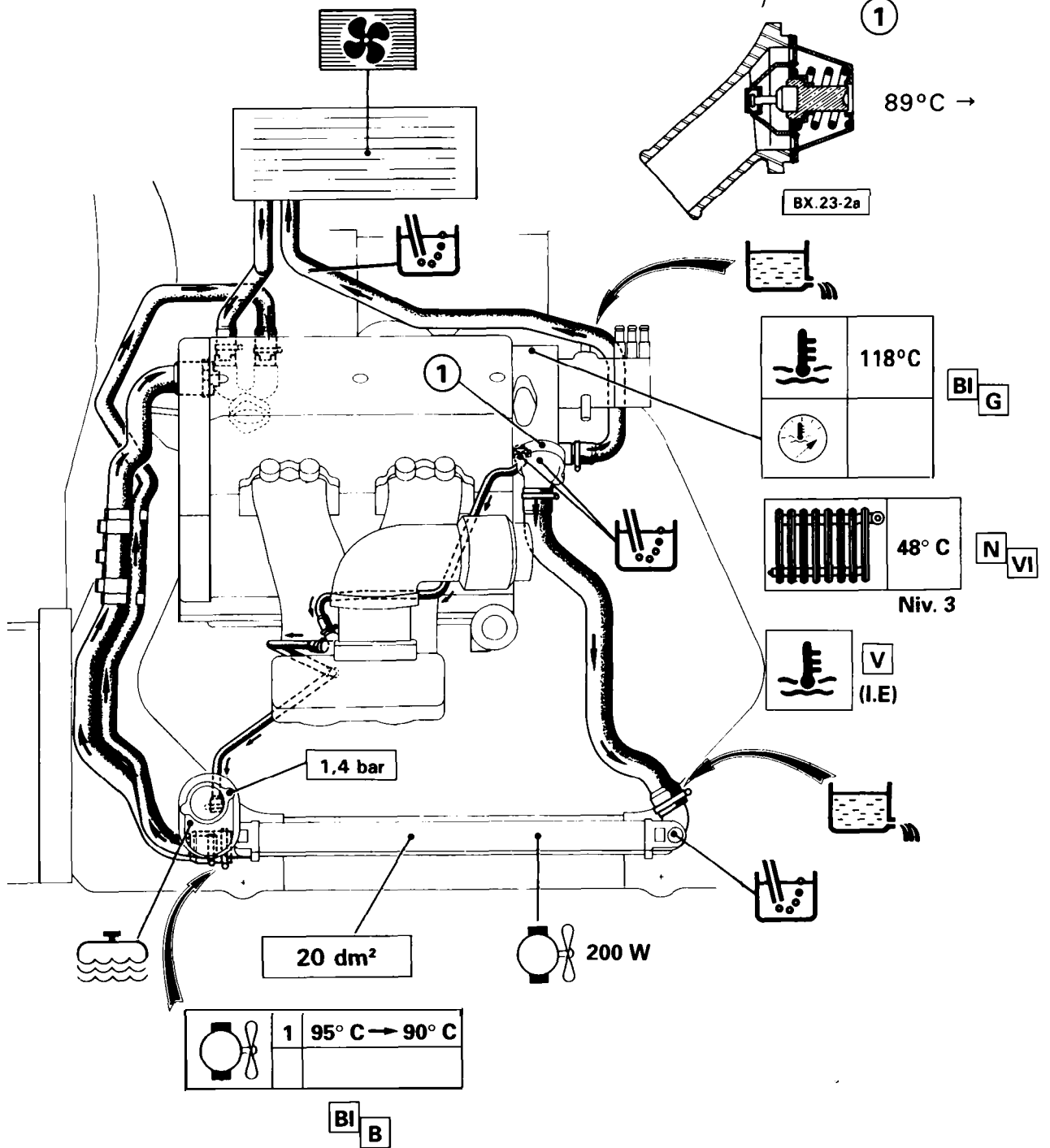
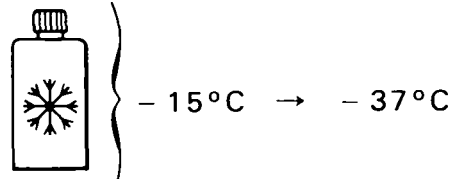
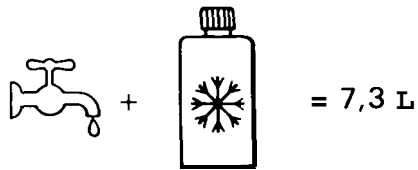
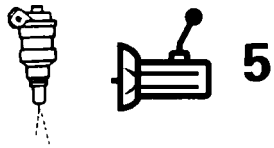

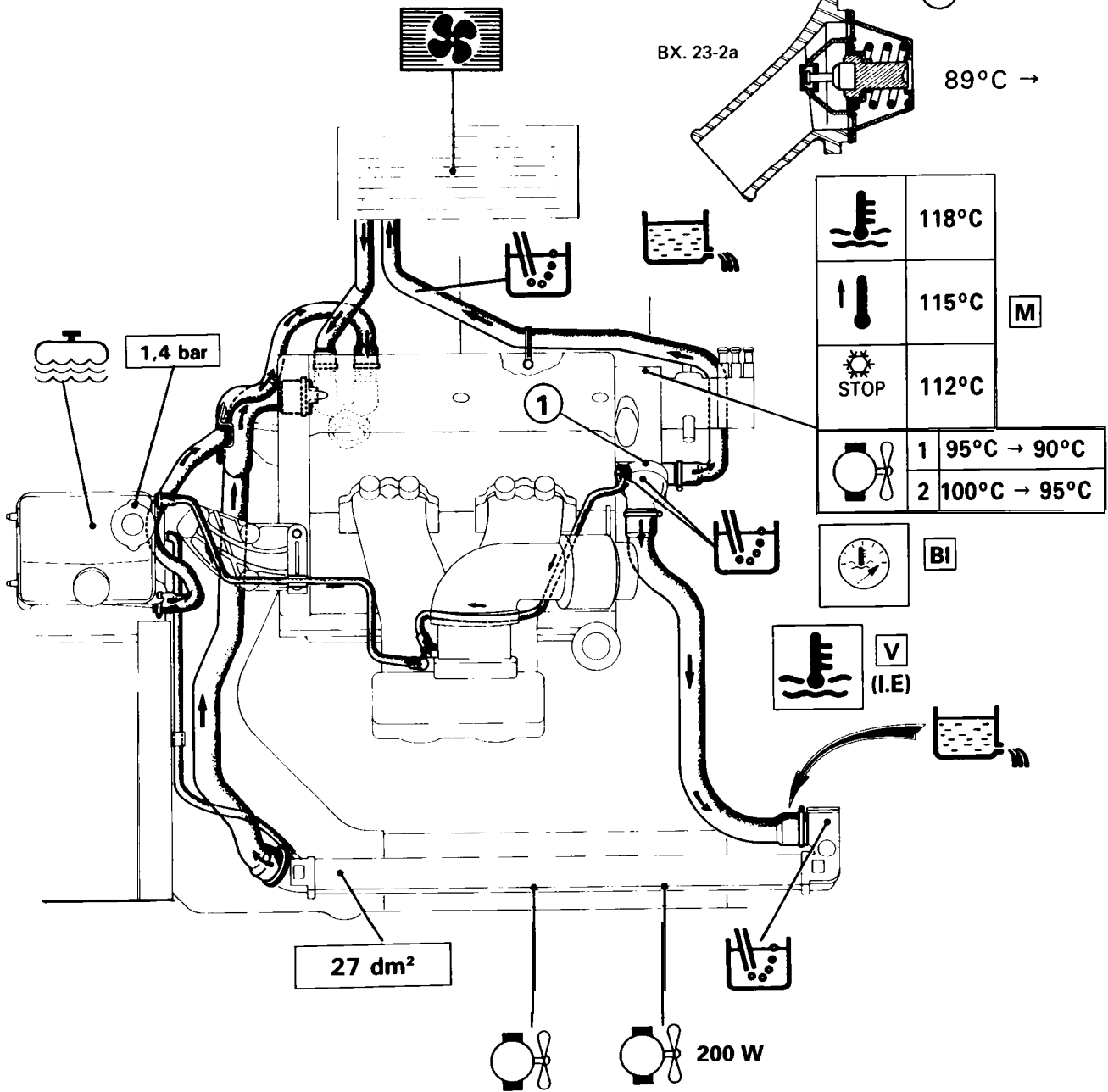
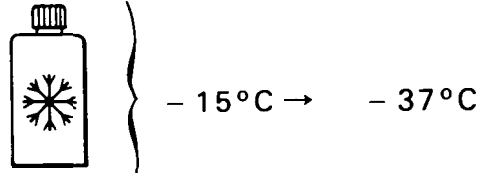
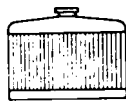



1



XU10

230-00/1

5



AUTO

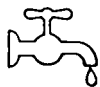

+



= 8,25 L



- 15° C



- 37° C

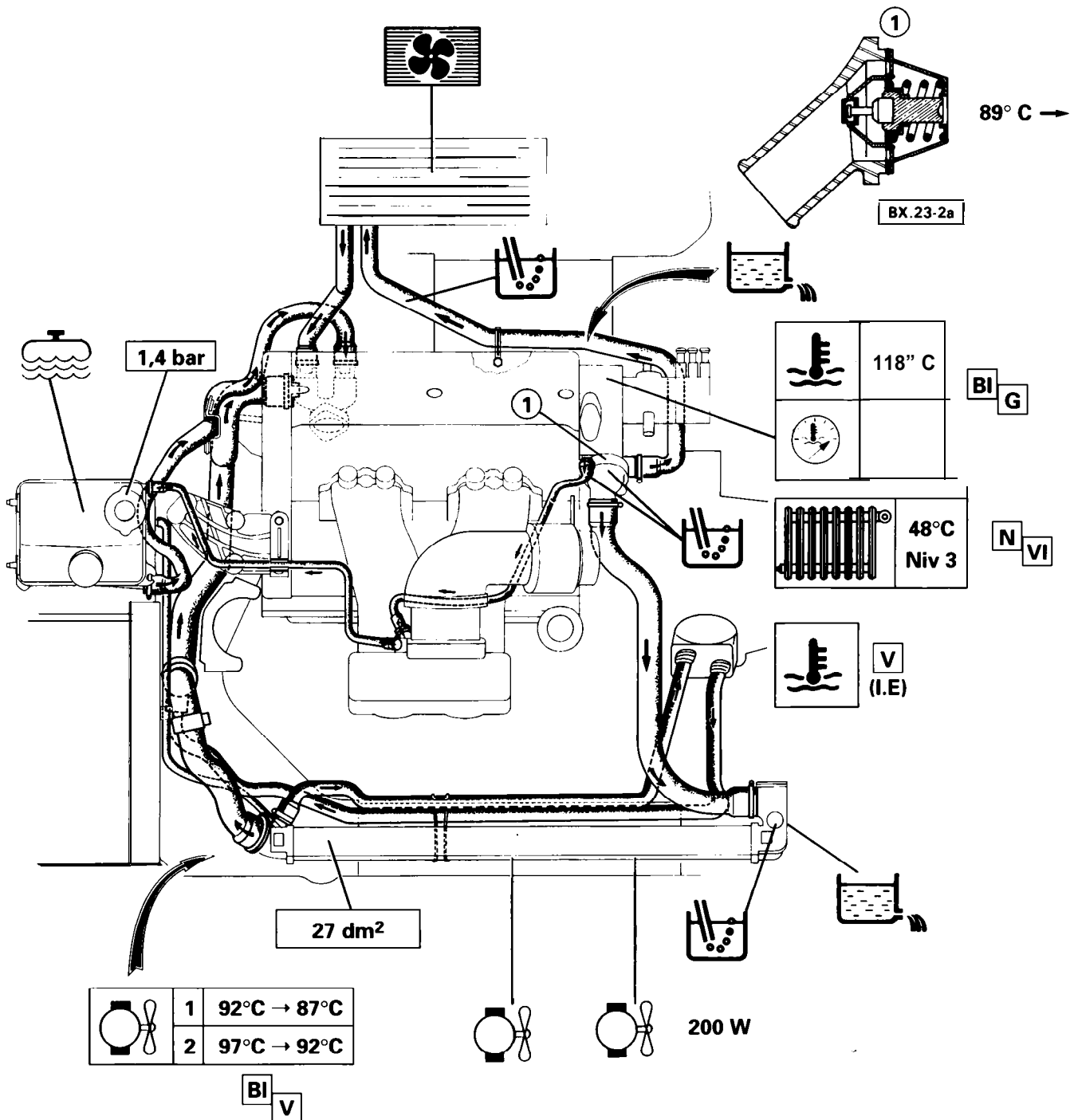

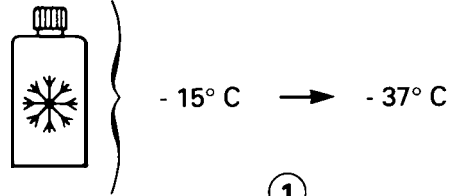
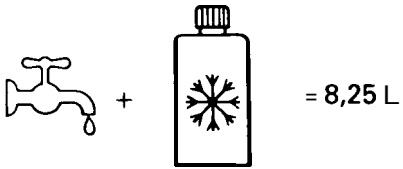
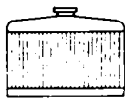

BX.23-2a

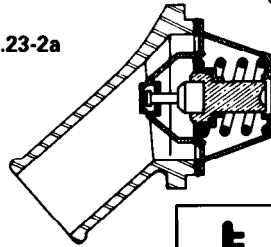

1

89° C →

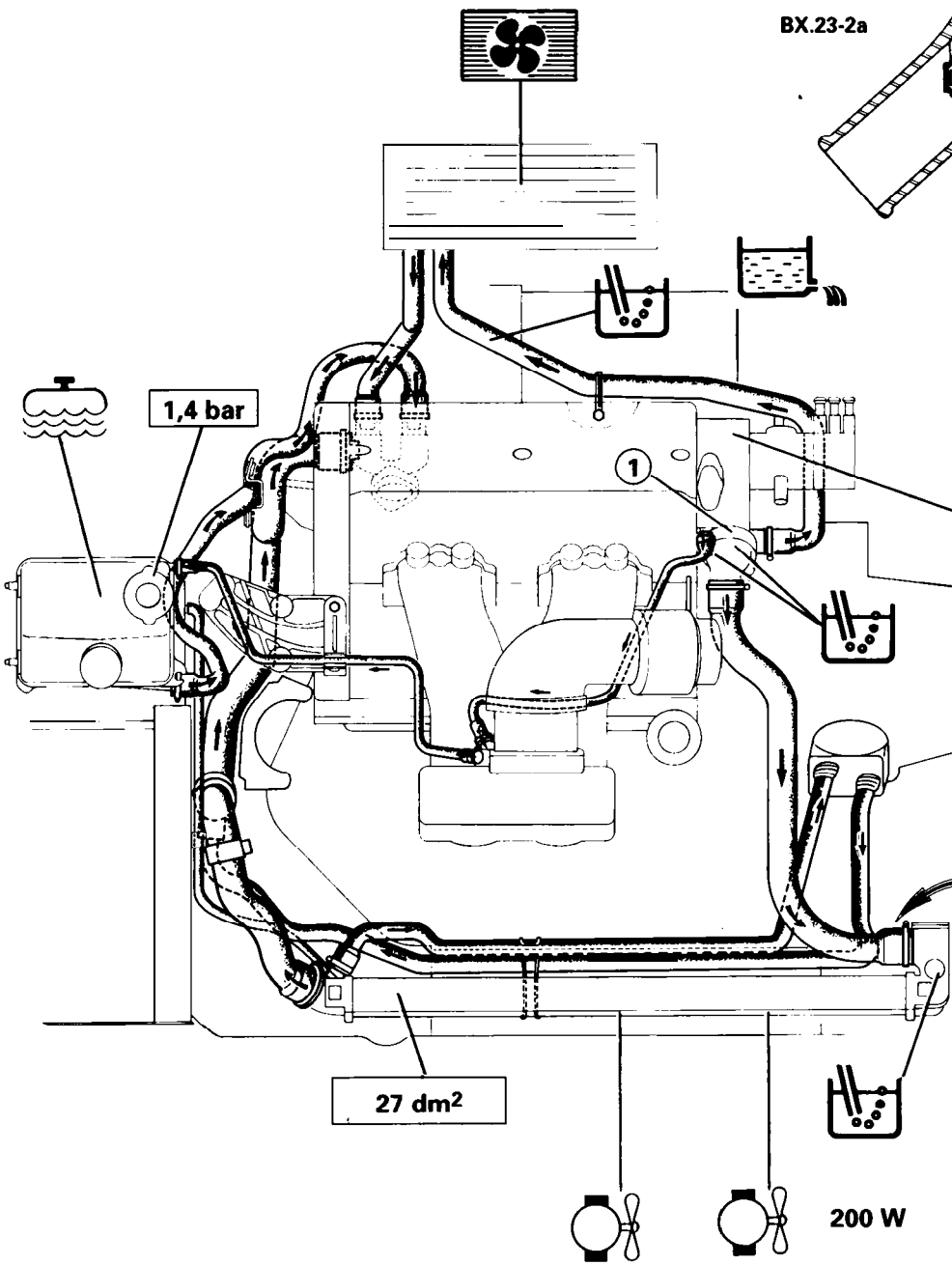

	118° C
	115° C
	112° C

M

	1	95° C → 90° C
	2	100° C → 95° C

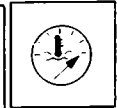

BI



V
(I.E)



1

TÖMNING OCH PÅFYLLNING
AV KYLSYSTEMET

Tömning

- Öppna tömningsskruven på kylaren.
- Öppna locket på kylarens påfyllningshål och luftningsskruven.

Påfyllning

- Placera påfyllningscylindern **4520-T** i kylarens påfyllningshål.
- Öppna luftningsskruvarna.
- Fyll på vätskan, och stäng luftningsskruvarna en efter en när kylvätskan flyter utan luftbubblor.
- Starta motorn och håll ett varvtal på 2000 varv/min,
Se till att vätskan hela tiden syns i påfyllningscylindern.
- Kör motorn tills kylfläkten/-arna först startar och sedan stannar igen.
- Stoppa motorn.
- Vänta tills motorn svalnat.
- Fyll på vätska upp till MAX.
- Skruva på locket.